

Nikuni KTM Series Pumps

(Micro Bubble Generator for DAF System)

Client :
Project :
Model : KTM20FD04ZM-000 (Cast Iron Material)

Date :
Doc. No. :
Revision No. :



Japan Headquarters :

843-5, Kuji, Takatsu-Ku, Kawasaki-Shi,
Kanagawa, Japan Post-code 213-0032

URL : <http://www.nikuni.co.jp>

Phone: +81-44-833-6500 (English)
+81-44-833-1121 (Japanese)

Fax : +81-44-833-6482

MAIN OFFICE :
 843-5 KUJI, TAKATU-KU, KAWASAKI, KANAGAWA, JAPAN 2130032
 TEL : +81(0)-44-833-6500 FAX: +81(0)44-833-6482



NIKUNI BUBBLE GENERATOR FOR DAF SYSTEM

NIKUNI KTM (DAF) PUMP DATA SHEET

Company		Date	
Project		Data sheet No.	
Service		Rev.	
Item No		PID No.	
No.Operating	No.Spare	Total Required	
Pump Model	KTM20FD04ZM-000 (Cast Iron Material)		
Pump Type	Closed Coupled Type / Monoblock Type		

PROCESS AND PERFORMANCE DATA

Conditions of Service, Each Pump

Fluid	Treated Water	Design Capacity (L/min / gpm)	/
Normal Capacity (L/min / m3/Hr)	16.6 / 1.0	Suction Press. (MPa / bar)	-0.03 / -0.3
Temperature (°C)		Disch. Press. (MPa / bar)	0.4 / 4
Specific Gravity (at P.T.)		Differential Press. (MPa / bar)	/
Viscosity (at P.T. MPa•s)		Total Head (m / bar)	30 or 40 / 3 or 4
Air Flow rate (NL/min / Nm3/Hr)	1.3 / 0.08	Differential Head (m / bar)	
NPSH Ava. (m)		NPSH Req. (m)	

Motor Driver

* Close-Coupled type means NIKUNI will supply integrated TEFC Indoor Motor together with KTM.

Phase	Three	Output (kW/HP)	0.56kW / 3/4 HP	Frequency	50 Hz
Voltage	200V - 415V	Pole	2	Speed	3000 min-1
Amperange	200V/2.5A, 380V/1.3A, 400V/1.3A, 415V/1.2A				

Connection

(Suction.)	Size	20 A	Rating	Rc 3/4
(Discharge.)	Size	15 A	Rating	Rc 1/2

Materials (Pump wetted parts)

Casing	FC200	Shaft	SUS316	Cover O-ring	NBR
Impeller	SUS403	Side plate	CAC406	Slinger	NBR
Cover	FC200	Mechanical Seal	Ceramics- Carbon , NBR		

Painting

MUNSELL N3

Remarks

Accessories :

Air In-take nozzle.

Please refer to attached recommendation of the air-parameter & guages ranges and other accessories.

REV.	DATE	COMMENT	DESCRIPTION	DRAWN BY	CHECK BY	APPROVED BY

Demension

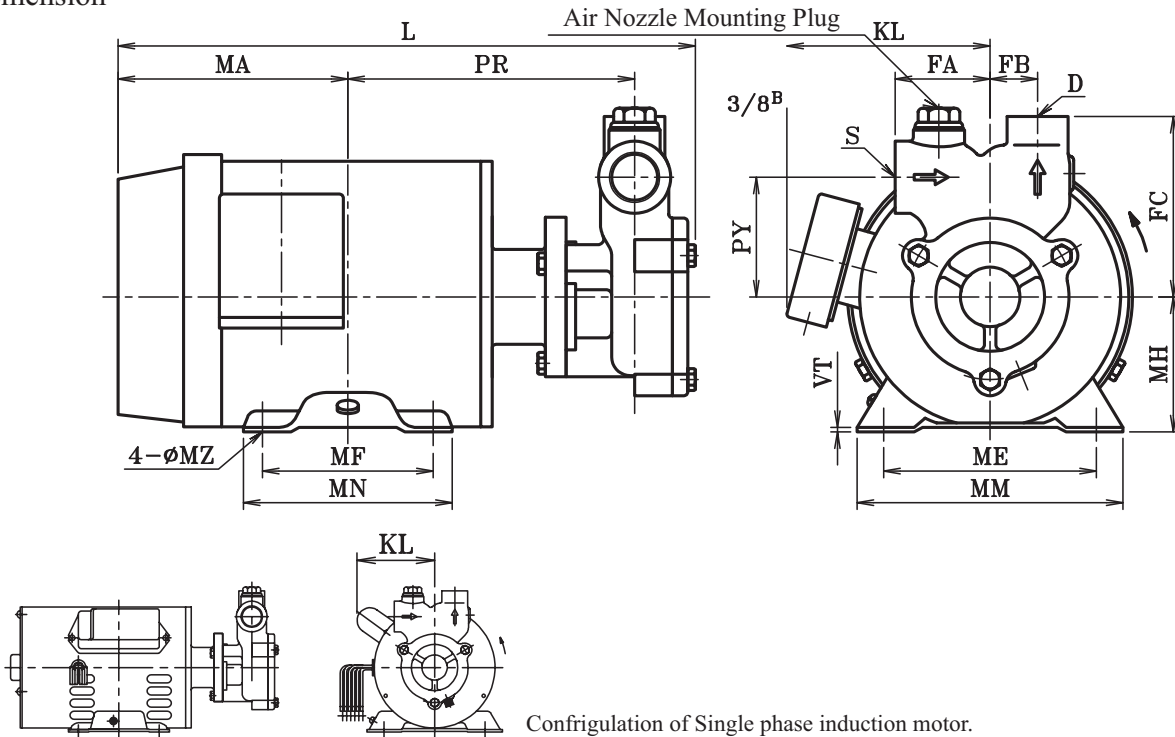

Demension & net weight

(Unit:mm,kg)

Model	kW	S	D	PR	PY	FA	FB	FC	MH	L	MA	ME	MF	MM	MN	MZ	VT	KL	Weight
KTM20FD04S	0.56	Rc3/4	Rc1/2	160.5	63	50	25	95	80	322.5	134	125	100	168	125	10×20	3.2	96	18
KTM20FD04Z	0.56	Rc3/4	Rc1/2	147	63	50	25	95	71	296	121	112	90	140	110	7×8	2.3	107	18
KTM25FD07Z	0.975	Rc1	Rc3/4	140	70	60	28	105	80	321	148	125	100	165	130	10×8	4.5	146	24
KTM32FD15Z	1.95	Rc1.1/4	Rc1	167.5	80	65	35	120	90	347.5	143	140	125	176	150	10×12	10	147	26
KTM40FD22Z	2.42	Rc1.1/2	Rc1.1/4	171.5	85	70	40	130	90	357.5	143	140	125	176	150	10×12	10	147	28

Sectional Drawing

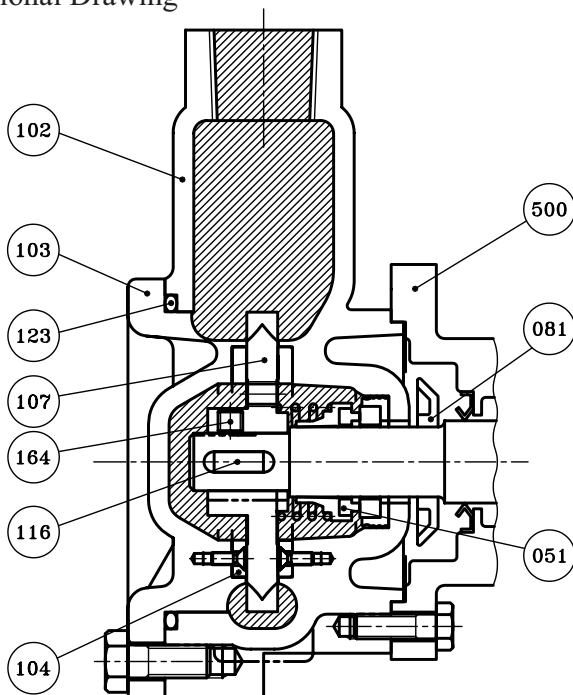

Material

No.	NAME OF PARTS	SET	MATERIALS
051	Mechanical Seal	1	Ceramics - Carbon
081	Slinger	1	NBR
102	Casing	1	FC200
103	Cover	1	FC200
104	Side Plates	2	CAC406
107	Impeller	1	SUS403
116	Key	1	SUS316
123	O-Ring	1	NBR
164	Set Screws	2	SUS316
500	Motor	1	





PUMP SUPPOSITION CURVE

50Hz

Model KTM20FD04

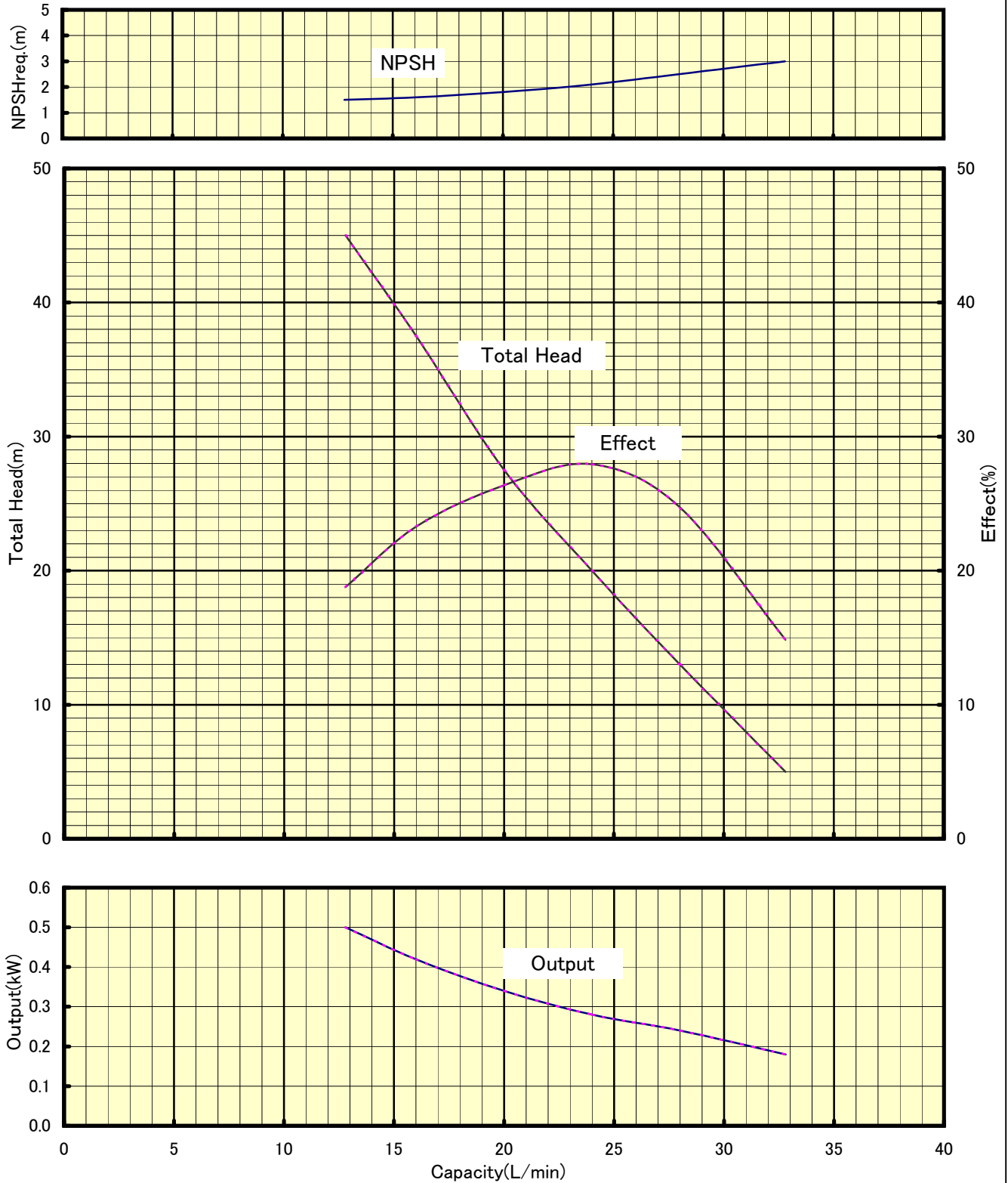

Air Intake Nozzle (Included in every package)

How to connect the nozzle to Air Flow Meter (Air Intake Nozzle will be attached to every pump)

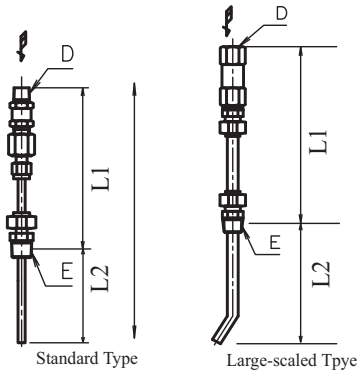

Applicable Model (Standard)	Dia. (E)	Length (L1)	Length (L2)	Length (L)	Dia. (D)
KTM15 (F)(N)(D)	R 3/8 ^B	121	73	157	R 1/4 ^B
KTM20 (F)(N)(D)	R 3/8 ^B	121	88	162	R 1/4 ^B
KTM25 (F)(N)(D)	R 3/8 ^B	121	97	167	R 1/4 ^B
KTM32 (F)(N)(D)	R 3/8 ^B	121	114	172	R 1/4 ^B
KTM40 (F)(N)(D)	R 3/8 ^B	121	120	177	R 1/4 ^B
KTM50 (F)(S)1,2,3	R 3/8 ^B	129	210	268	R 1/4 ^B

Applicable Model (Large-scaled Type)	Dia. (E)	Length (L1)	Length (L2)	Length (L)	Dia. (D)
KTM65S2 / F2	Rc 3/8	183	240	304	Rc 3/8
KTM80S / F	Rc 3/8	193	240	319	Rc 3/8

* In case of KTM80S / F model, connect "E" part with Bushing (3/4 x 3/8)

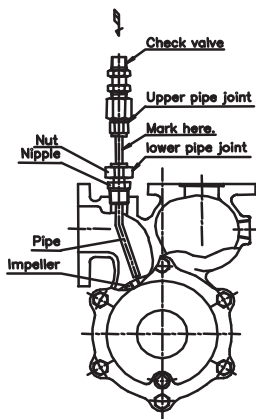

- 1) Loosen the nuts of the lower pipe joint to allow a nipple to freely move.
- 2) Mark the pipe bending direction on the pipe surface between the upper and lower pipe joints.
- 3) Wind a sealing tape around the lower pipe joint's nipple of the suction nozzle, insert it into the nozzle junction of the pump, and turn the nipple to firmly fix it.
- 4) Turn the pipe to align the mark on the pipe surface so that the bend nose (gas discharge port) of the pipe will be directed to the center of the impeller.
- 5) Tighten the nuts of the lower pipe joint firmly. Make sure that the suction nozzle is not manually rotated.
- 6) Rotate the motor manually (rotate the shaft end of the motor with a screwdriver) to make sure that the pipe nose of the nozzle is not interfering with the impeller.

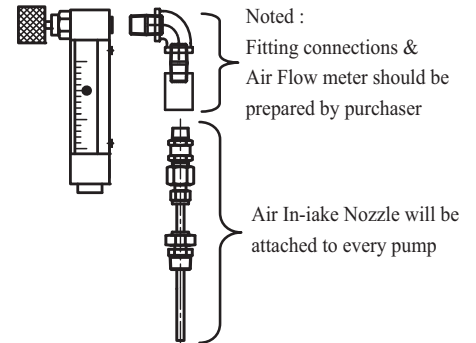

Recommended Accessories (To be prepared by Purchaser)

Air Parameter

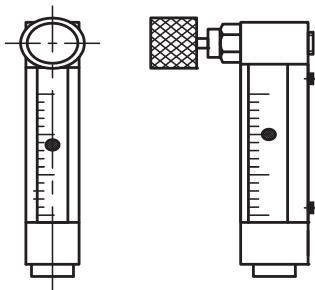

Guages

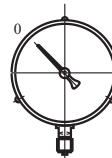

Compound Gauge
 Minus 0.1 MPa to + 0.25MPa
 Minus 1.0 Bar to + 2.5 Bar
 Minus 15psi to + 35 psi



Pressure Gauge
 0 MPa to + 1.0MPa
 0 Bar to + 10 Bar
 0 psi to + 150 psi

Operation air flow rate & Air Parameter ranges

50Hz Frequency

Applicable Model (Standard)	Water Flow Rate m ³ /Hr x 4Bar	Operation Air flow rate (N·L/min)	Air Flow Meter Range (N·L/min)
KTM20 (F)(N)(D)	1.0	1.3	0 to 5
KTM25 (F)(N)(D)	1.5	2.0	0 to 5
KTM32 (F)(N)(D)	3.0	4.0	0 to 10
KTM40 (F)(N)(D)	4.8	6.4	0 to 10
KTM50S1 / F1	8.0	10.6	0 to 20
KTM50S2 / F2	12.0	16.0	0 to 20
KTM50S3 / F3	15.0	20.0	0 to 30
KTM65S2 / F2	20.0	26.6	0 to 40
KTM80S / F	42.0	56.0	0 to 80

60Hz Frequency

Water Flow Rate m ³ /Hr x 4Bar	Operation Air flow rate (N·L/min)	Air Flow Meter Range (N·L/min)
1.3	1.7	0 to 5
2.5	3.3	0 to 5
4.0	5.3	0 to 10
7.0	9.3	0 to 20
11.5	15.0	0 to 30
15.0	20.0	0 to 40
18.0	24.0	0 to 40
28.0	38.0	0 to 60
58.0	78.0	0 to 100

The KTM Series pump user manual must be fully read and understood before operating the pump. Failure to do so may result in death, serious injury, or property damage. This page is intended for a basic understanding of the KTM startup operation and is not a substitute for the user manual.

PRE-OPERATION CHECK (POWER OFF)

- 1) Prime KTM with effluent or water
- 2) Fully open Suction valve and Discharge valve. Do not run KTM with these valves closed.

STARTING THE KTM

- 1) Discharge side adjustments:

Slowly tighten the Discharge valve until the discharge pressure falls within the desired range of 0.3MPa to 0.4Mpa (approximately 3 bar to 4 bar) with reference to the Pressure gauge. In the case where the Discharge valve (or KTM) is located far from the flotation tank, bubbles will tend to grow larger. In order to maintain microbubble size, an additional control valve should be installed on the flotation tank side to control the discharge pressure.

- 2) Suction side adjustments:

Check to see if the Compound gauge indicates a negative suction pressure between the range of -0.02MPa to -0.03MPa (approximately -0.2 bar to -0.3 bar). If the pressure is higher than this range, slightly tighten the Suction valve to bring the pressure into the range stated above.

- 3) Air injection adjustments:

Open the knob of Air-Parameter (Air flow meter) and adjust to an air flow rate that is 8% of the water flow rate.

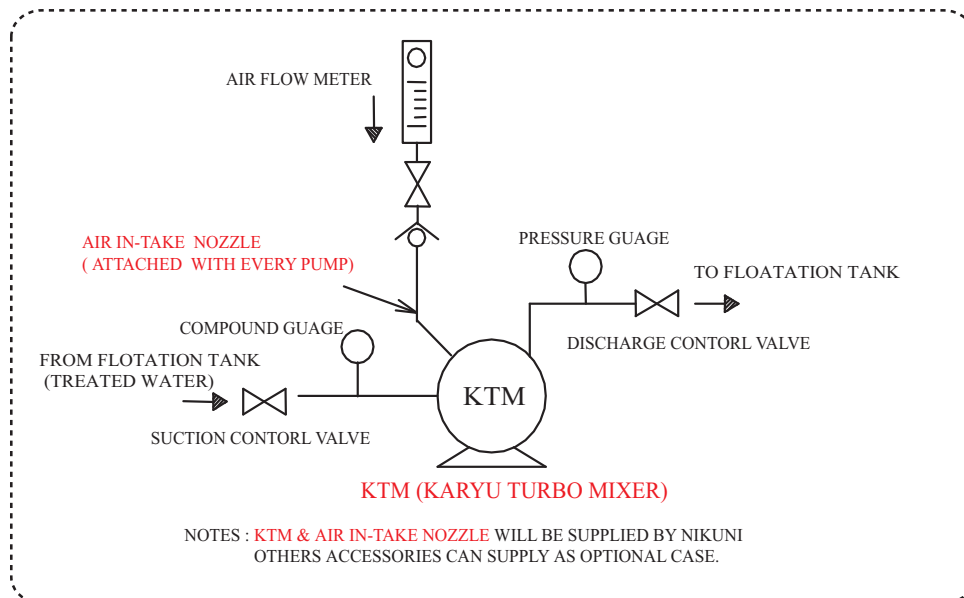

In case of mini bubbles occur and effect to flotation process,
please consider installing Excess Air Device / Separation Tank as shown in next page.

Reference P&ID for DAF System

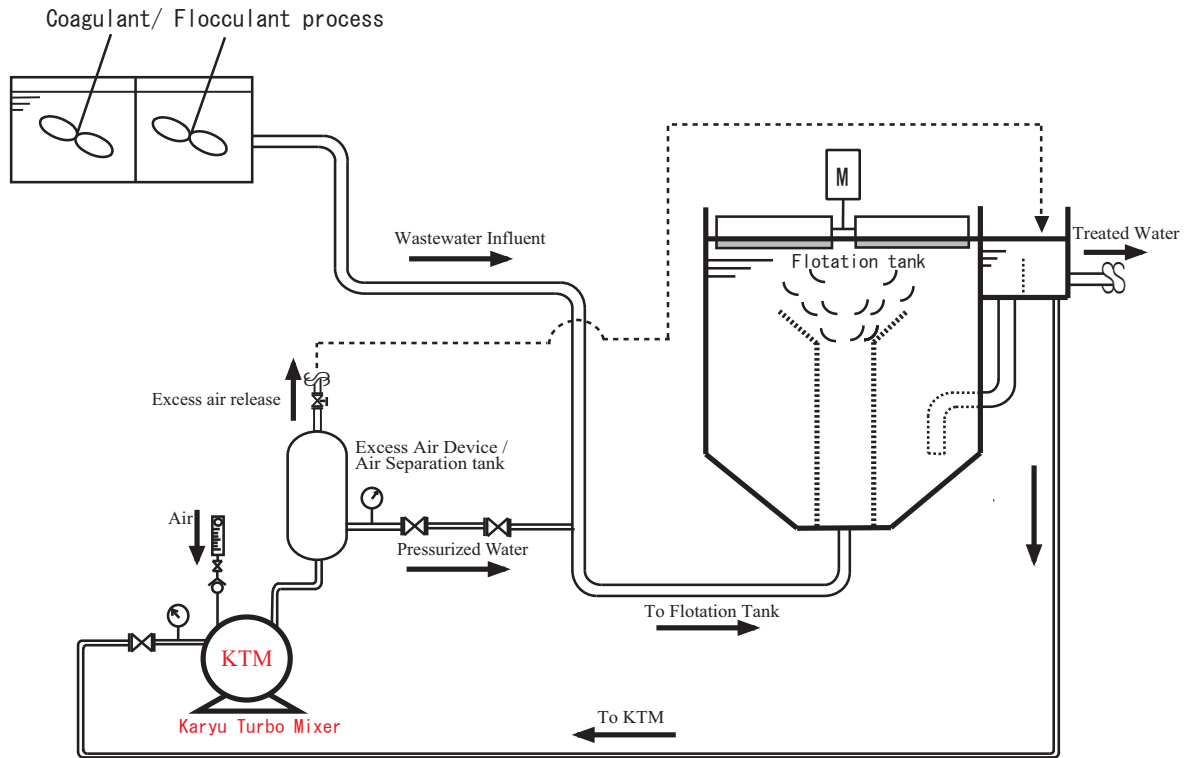

Recommended Separation Tank Capacity

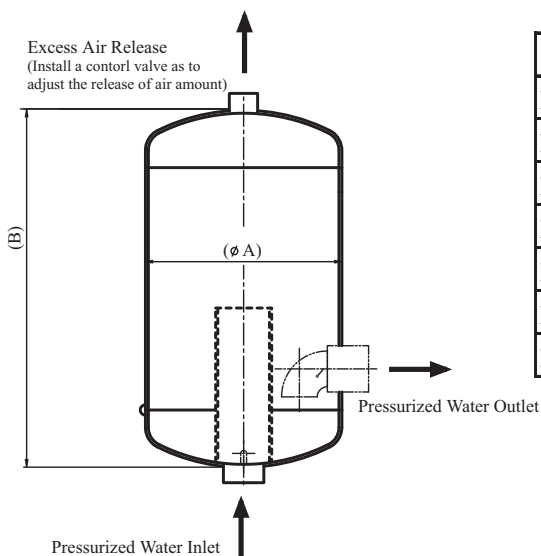

Model	A (mm)	B (mm)	Capacity (Liter)
KTM20N(F)(D)	100	260	2
KTM25N(F)(D)	120	350	4
KTM32N(F)(D)	260	400	20
KTM40N(F)(D)	260	400	20
KTM50S(F)1,S(F)2,S(F)3	300	850	60
KTM65S(F)2	450	900	140
KTM80S(F)	450	900	140