

Demension

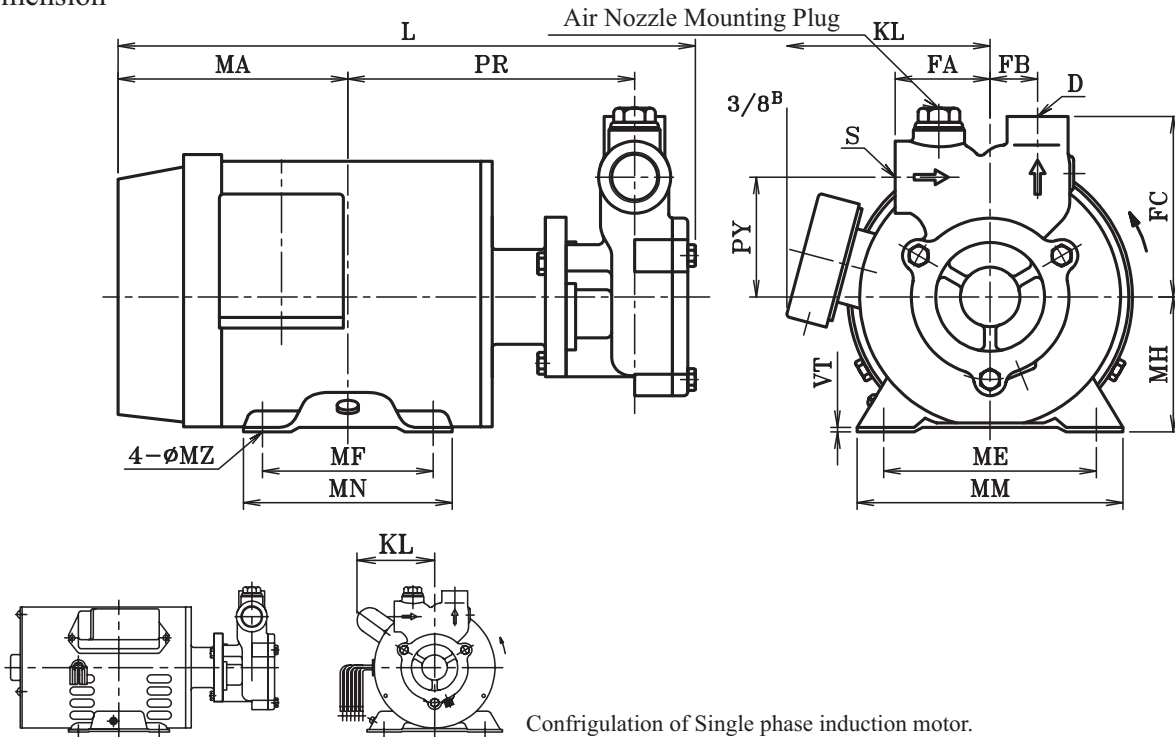

Demension & net weight

(Unit:mm,kg)

| Model | kW | S | D | PR | PY | FA | FB | FC | MH | L | MA | ME | MF | MM | MN | MZ | VT | KL | Weight |
|------------|-------|---------|---------|-------|----|----|----|-----|----|-------|-----|-----|-----|-----|-----|-------|-----|-----|--------|
| KTM20FD04S | 0.56 | Rc3/4 | Rc1/2 | 160.5 | 63 | 50 | 25 | 95 | 80 | 322.5 | 134 | 125 | 100 | 168 | 125 | 10×20 | 3.2 | 96 | 18 |
| KTM20FD04Z | 0.56 | Rc3/4 | Rc1/2 | 147 | 63 | 50 | 25 | 95 | 71 | 296 | 121 | 112 | 90 | 140 | 110 | 7×8 | 2.3 | 107 | 18 |
| KTM25FD07Z | 0.975 | Rc1 | Rc3/4 | 140 | 70 | 60 | 28 | 105 | 80 | 321 | 148 | 125 | 100 | 165 | 130 | 10×8 | 4.5 | 146 | 24 |
| KTM32FD15Z | 1.95 | Rc1.1/4 | Rc1 | 167.5 | 80 | 65 | 35 | 120 | 90 | 347.5 | 143 | 140 | 125 | 176 | 150 | 10×12 | 10 | 147 | 26 |
| KTM40FD22Z | 2.42 | Rc1.1/2 | Rc1.1/4 | 171.5 | 85 | 70 | 40 | 130 | 90 | 357.5 | 143 | 140 | 125 | 176 | 150 | 10×12 | 10 | 147 | 28 |

Sectional Drawing

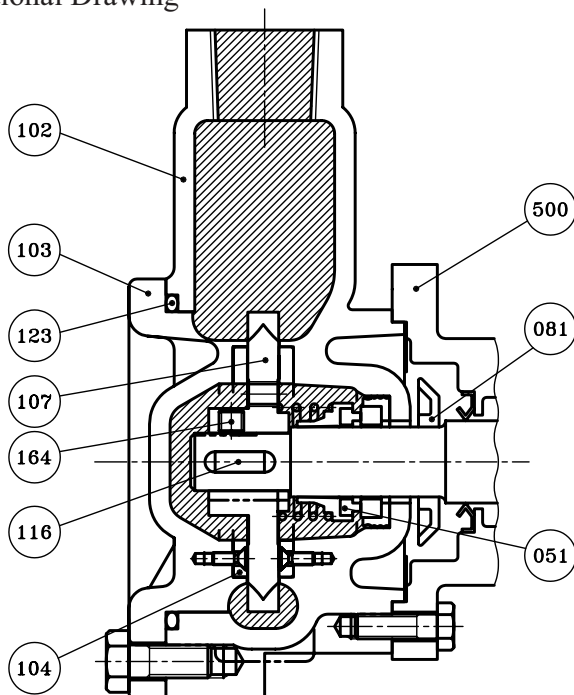

Material

| No. | NAME OF PARTS | SET | MATERIALS |
|-----|-----------------|-----|-------------------|
| 051 | Mechanical Seal | 1 | Ceramics - Carbon |
| 081 | Slinger | 1 | NBR |
| 102 | Casing | 1 | FC200 |
| 103 | Cover | 1 | FC200 |
| 104 | Side Plates | 2 | CAC406 |
| 107 | Impeller | 1 | SUS403 |
| 116 | Key | 1 | SUS316 |
| 123 | O-Ring | 1 | NBR |
| 164 | Set Screws | 2 | SUS316 |
| 500 | Motor | 1 | |





PUMP SUPPOSITION CURVE

50Hz

Model KTM32FD15

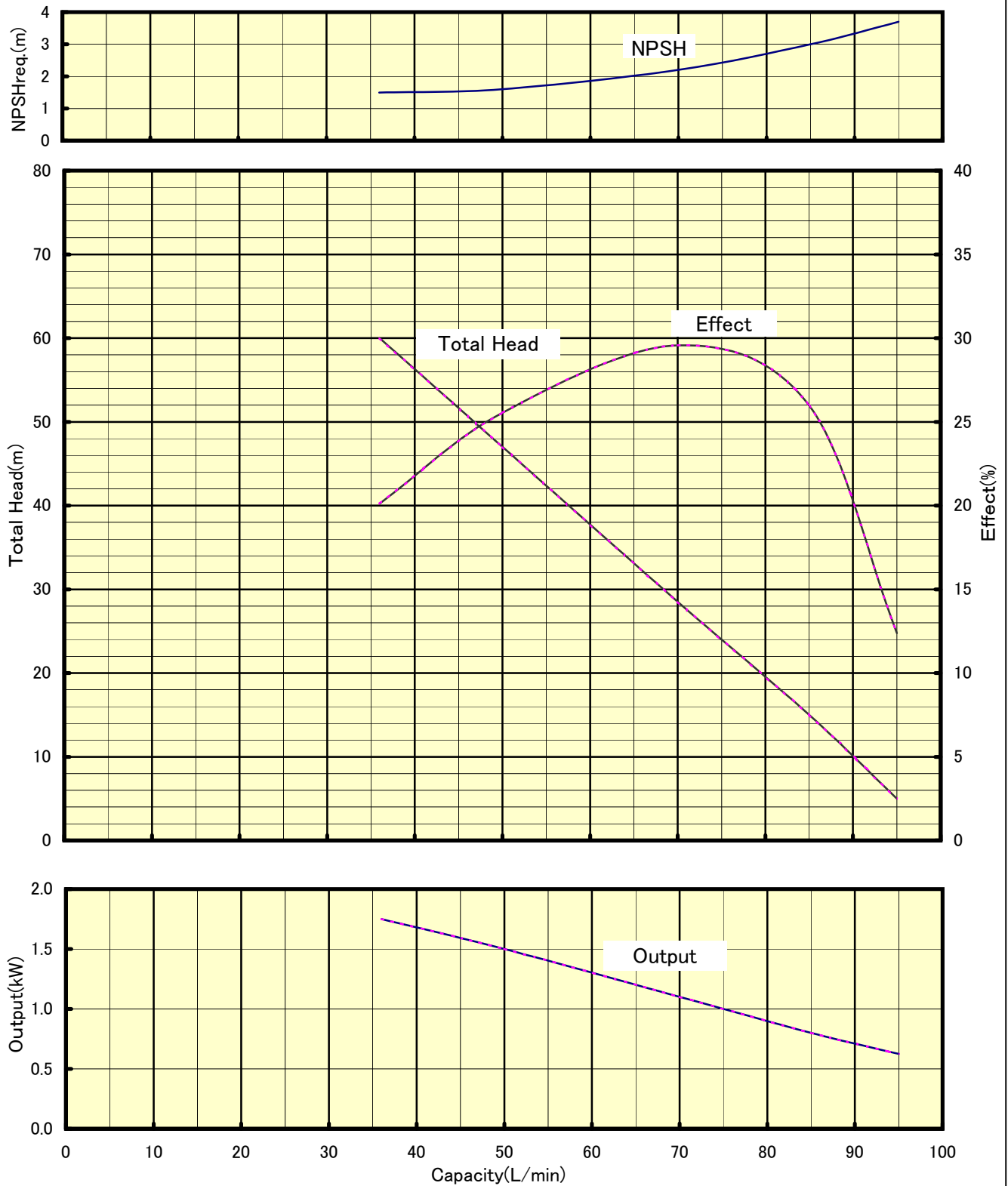

Air Intake Nozzle (Included in every package)

How to connect the nozzle to Air Flow Meter (Air Intake Nozzle will be attached to every pump)

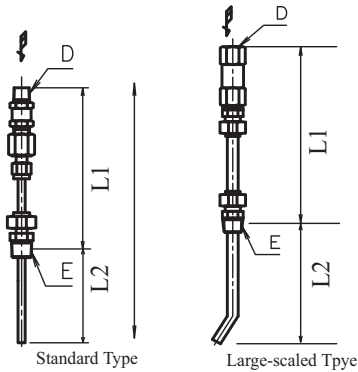

| Applicable Model (Standard) | Dia. (E) | Length (L1) | Length (L2) | Length (L) | Dia. (D) |
|-----------------------------|--------------------|-------------|-------------|------------|--------------------|
| KTM15 (F)(N)(D) | R 3/8 ^B | 121 | 73 | 157 | R 1/4 ^B |
| KTM20 (F)(N)(D) | R 3/8 ^B | 121 | 88 | 162 | R 1/4 ^B |
| KTM25 (F)(N)(D) | R 3/8 ^B | 121 | 97 | 167 | R 1/4 ^B |
| KTM32 (F)(N)(D) | R 3/8 ^B | 121 | 114 | 172 | R 1/4 ^B |
| KTM40 (F)(N)(D) | R 3/8 ^B | 121 | 120 | 177 | R 1/4 ^B |
| KTM50 (F)(S)1,2,3 | R 3/8 ^B | 129 | 210 | 268 | R 1/4 ^B |

| Applicable Model (Large-scaled Type) | Dia. (E) | Length (L1) | Length (L2) | Length (L) | Dia. (D) |
|--------------------------------------|----------|-------------|-------------|------------|----------|
| KTM65S2 / F2 | Rc 3/8 | 183 | 240 | 304 | Rc 3/8 |
| KTM80S / F | Rc 3/8 | 193 | 240 | 319 | Rc 3/8 |

* In case of KTM80S / F model, connect "E" part with Bushing (3/4 x 3/8)

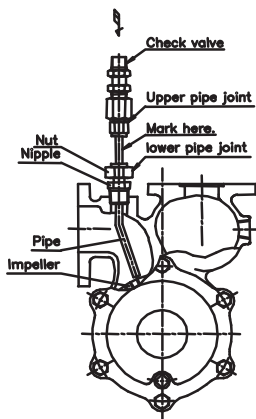

- 1) Loosen the nuts of the lower pipe joint to allow a nipple to freely move.
- 2) Mark the pipe bending direction on the pipe surface between the upper and lower pipe joints.
- 3) Wind a sealing tape around the lower pipe joint's nipple of the suction nozzle, insert it into the nozzle junction of the pump, and turn the nipple to firmly fix it.
- 4) Turn the pipe to align the mark on the pipe surface so that the bend nose (gas discharge port) of the pipe will be directed to the center of the impeller.
- 5) Tighten the nuts of the lower pipe joint firmly. Make sure that the suction nozzle is not manually rotated.
- 6) Rotate the motor manually (rotate the shaft end of the motor with a screwdriver) to make sure that the pipe nose of the nozzle is not interfering with the impeller.

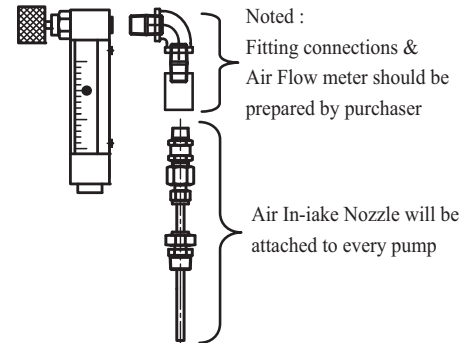

Recommended Accessories (To be prepared by Purchaser)

Air Parameter

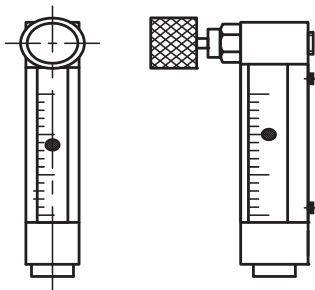

Guages

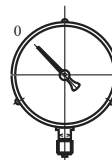

Compound Gauge
 Minus 0.1 MPa to + 0.25MPa
 Minus 1.0 Bar to + 2.5 Bar
 Minus 15psi to + 35 psi



Pressure Gauge
 0 MPa to + 1.0MPa
 0 Bar to + 10 Bar
 0 psi to + 150 psi

Operation air flow rate & Air Parameter ranges

50Hz Frequency

| Applicable Model (Standard) | Water Flow Rate m ³ /Hr x 4Bar | Operation Air flow rate (N·L/min) | Air Flow Meter Range (N·L/min) |
|-----------------------------|--|--------------------------------------|-----------------------------------|
| KTM20 (F)(N)(D) | 1.0 | 1.3 | 0 to 5 |
| KTM25 (F)(N)(D) | 1.5 | 2.0 | 0 to 5 |
| KTM32 (F)(N)(D) | 3.0 | 4.0 | 0 to 10 |
| KTM40 (F)(N)(D) | 4.8 | 6.4 | 0 to 10 |
| KTM50S1 / F1 | 8.0 | 10.6 | 0 to 20 |
| KTM50S2 / F2 | 12.0 | 16.0 | 0 to 20 |
| KTM50S3 / F3 | 15.0 | 20.0 | 0 to 30 |
| KTM65S2 / F2 | 20.0 | 26.6 | 0 to 40 |
| KTM80S / F | 42.0 | 56.0 | 0 to 80 |

60Hz Frequency

| Water Flow Rate m ³ /Hr x 4Bar | Operation Air flow rate (N·L/min) | Air Flow Meter Range (N·L/min) |
|--|--------------------------------------|-----------------------------------|
| 1.3 | 1.7 | 0 to 5 |
| 2.5 | 3.3 | 0 to 5 |
| 4.0 | 5.3 | 0 to 10 |
| 7.0 | 9.3 | 0 to 20 |
| 11.5 | 15.0 | 0 to 30 |
| 15.0 | 20.0 | 0 to 40 |
| 18.0 | 24.0 | 0 to 40 |
| 28.0 | 38.0 | 0 to 60 |
| 58.0 | 78.0 | 0 to 100 |

The KTM Series pump user manual must be fully read and understood before operating the pump. Failure to do so may result in death, serious injury, or property damage. This page is intended for a basic understanding of the KTM startup operation and is not a substitute for the user manual.

PRE-OPERATION CHECK (POWER OFF)

- 1) Prime KTM with effluent or water
- 2) Fully open Suction valve and Discharge valve. Do not run KTM with these valves closed.

STARTING THE KTM

- 1) Discharge side adjustments:

Slowly tighten the Discharge valve until the discharge pressure falls within the desired range of 0.3MPa to 0.4Mpa (approximately 3 bar to 4 bar) with reference to the Pressure gauge. In the case where the Discharge valve (or KTM) is located far from the flotation tank, bubbles will tend to grow larger. In order to maintain microbubble size, an additional control valve should be installed on the flotation tank side to control the discharge pressure.

- 2) Suction side adjustments:

Check to see if the Compound gauge indicates a negative suction pressure between the range of -0.02MPa to -0.03MPa (approximately -0.2 bar to -0.3 bar). If the pressure is higher than this range, slightly tighten the Suction valve to bring the pressure into the range stated above.

- 3) Air injection adjustments:

Open the knob of Air-Parameter (Air flow meter) and adjust to an air flow rate that is 8% of the water flow rate.

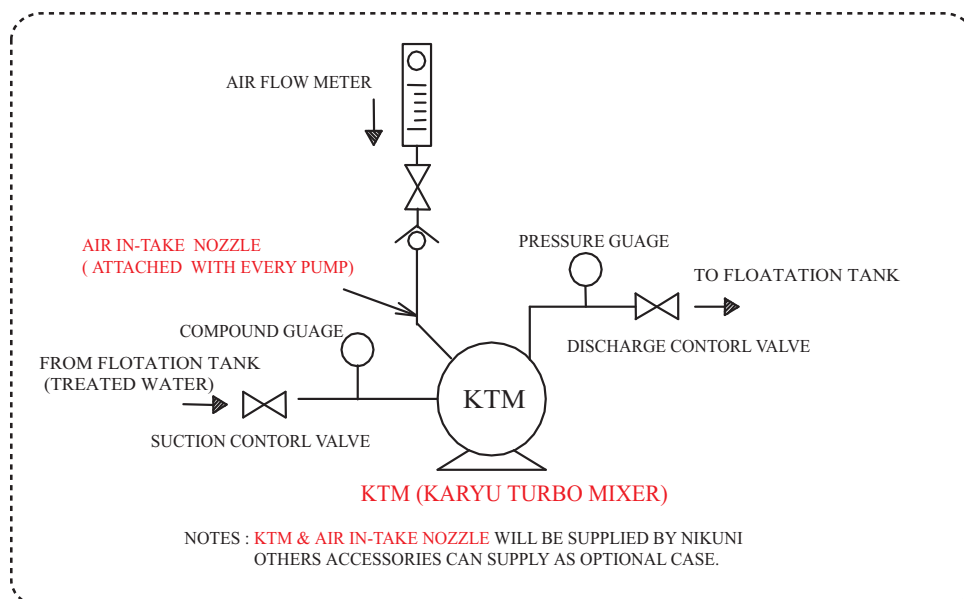

In case of mini bubbles occur and effect to flotation process,
please consider installing Excess Air Device / Separation Tank as shown in next page.

Reference P&ID for DAF System

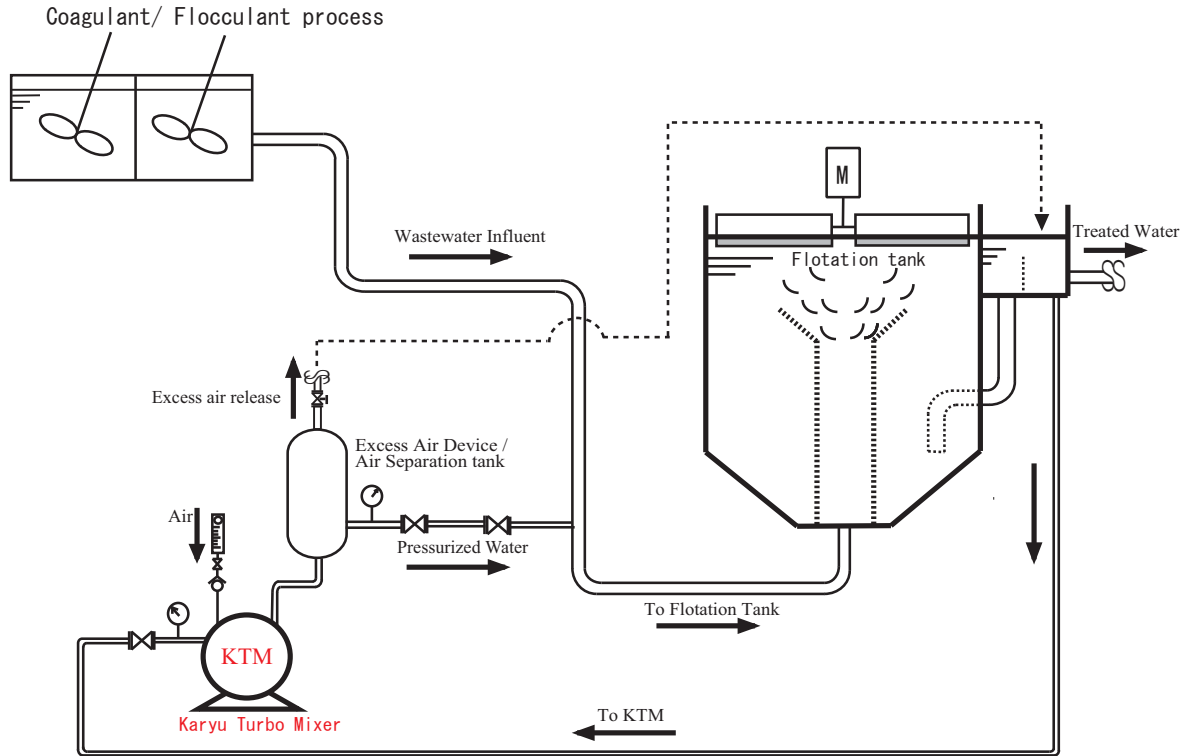

Recommended Separation Tank Capacity

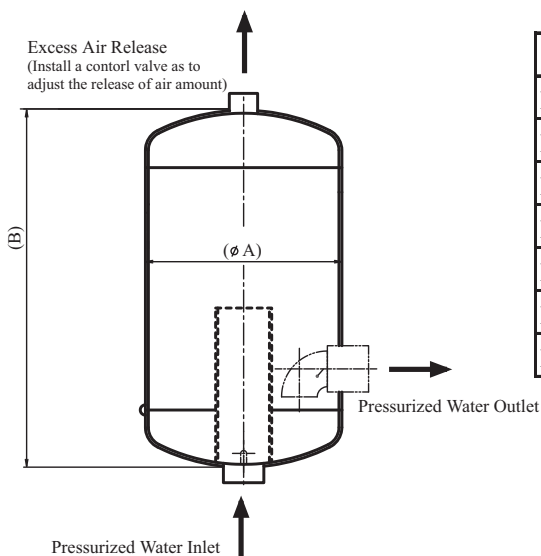

| Model | A (mm) | B (mm) | Capacity (Liter) |
|------------------------|--------|--------|------------------|
| KTM20N(F)(D) | 100 | 260 | 2 |
| KTM25N(F)(D) | 120 | 350 | 4 |
| KTM32N(F)(D) | 260 | 400 | 20 |
| KTM40N(F)(D) | 260 | 400 | 20 |
| KTM50S(F)1,S(F)2,S(F)3 | 300 | 850 | 60 |
| KTM65S(F)2 | 450 | 900 | 140 |
| KTM80S(F) | 450 | 900 | 140 |